

6' PICTURE FRAME FENCE INSTALLATION INSTRUCTIONS

BEFORE YOU BEGIN

1. VERIFY LOCATION OF UNDERGROUND UTILITIES BEFORE YOU BEGIN.
2. LOCATE PROPERTY LINES.
3. CONSULT LOCAL AND REGIONAL BUILDING CODES BEFORE YOU BEGIN.
4. ALWAYS WEAR APPROPRIATE SAFETY EQUIPMENT.
5. STANDARD WOODWORKING TOOLS MAY BE USED FOR INSTALLATION.

POST INSTALLATION

1. DIG 12" DIAMETER HOLES 24" TO 36" DEEP DEPENDING ON LOCAL BUILDING CODES.
2. ADD 2" OF GRAVEL TO BOTTOM OF HOLES.
3. SET POSTS IN 24" MINIMUM OF CONCRETE.
4. BEFORE CONCRETE SETS, PLUMB AND LEVEL POSTS MAKING SURE TO USE A STRING-LINE TO MAINTAIN ALIGNMENT.
5. ALLOW CONCRETE TO PROPERLY SET BEFORE PROCEEDING TO NEXT STEP.

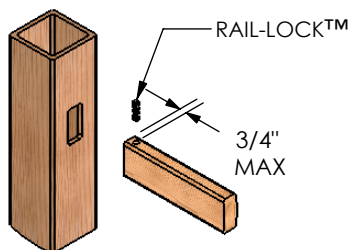
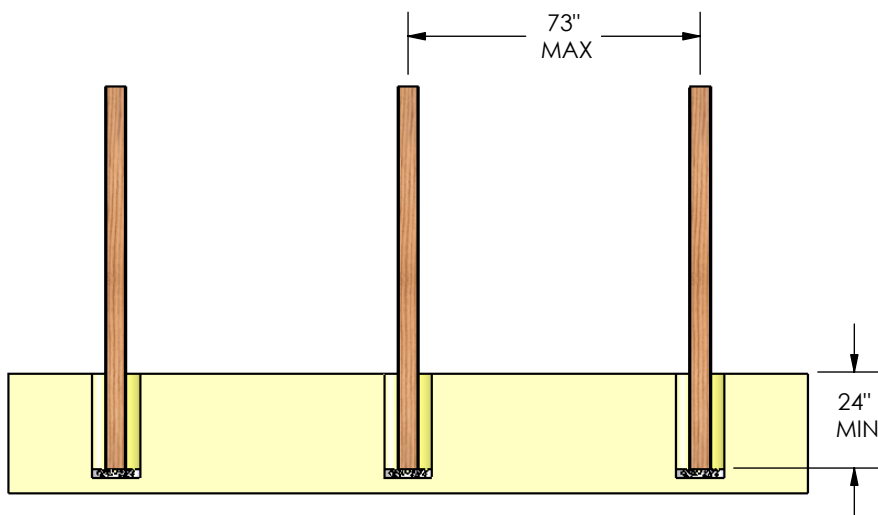

RAILING INSTALLATION

1. INSTALL RAIL-LOCKS™ IN RAILS AS SHOWN.
2. DRILL 17/32" DIA HOLE IN RAIL 1-1/8" DEEP AS SHOWN.
3. INSERT RAIL-LOCK™ INTO HOLE FLAT SIDE DOWN.
4. COMPRESS RAIL-LOCK AND SLIDE RAIL INTO PRE-ROUTED HOLE IN POST.
5. RAIL-LOCK™ WILL EXPAND TO KEEP RAIL FROM FALLING OUT ONCE RAIL IS INSTALLED INTO POST.

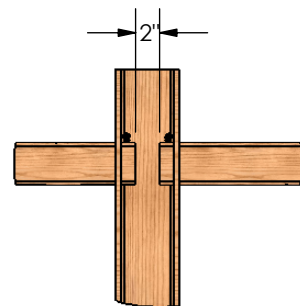

NOTE: LEAVE 2" GAP BETWEEN RAILS ENDS TO ALLOW FOR EXPANSION.

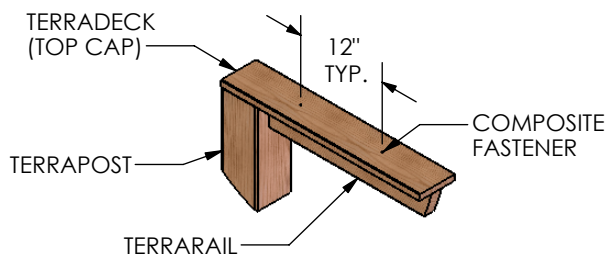

TOP CAP INSTALLATION

1. INSTALL TOP CAP USING TERRADECK PREMIUM BOARD.
2. ATTACH TOP CAP USING RECOMMENDED COMPOSITE FASTENERS. FASTENERS SHOULD BE POSITION AS TO JOIN THE TOP CAP AND RAIL TOGETHER SPACED 12" APART.

NOTE: IT IS RECOMMENDED TO LEAVE A 3/16" GAP BETWEEN TOP CAP BOARDS ALLOW FOR EXPANSION.

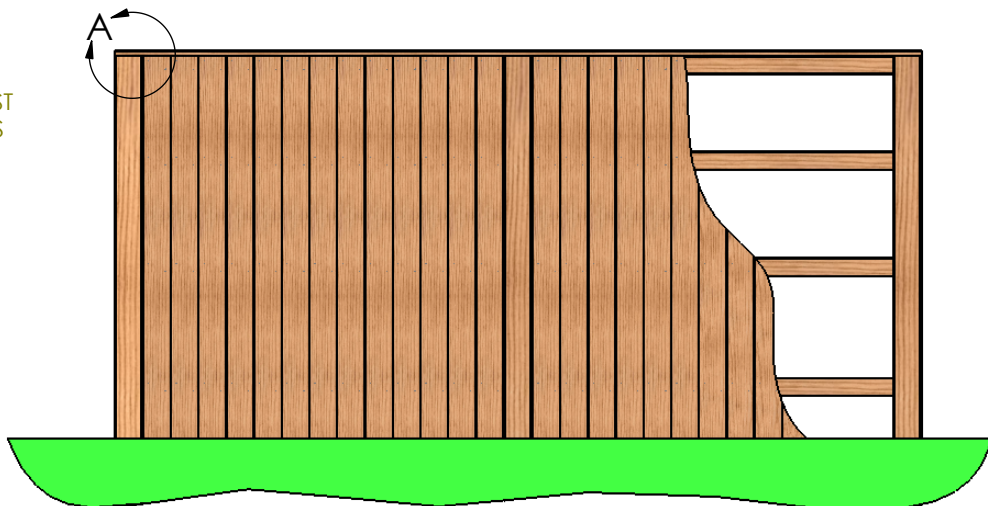
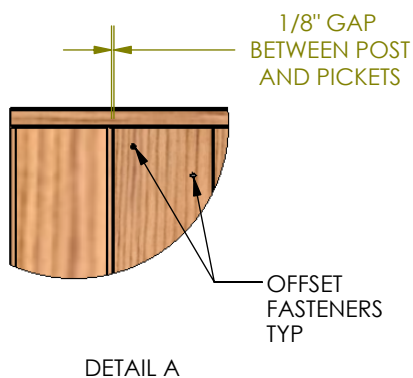

PICKET INSTALLATION

1. ATTACH PICKETS TO RAILS USING RECOMMENDED COMPOSITE FASTENERS.
- NOTE: IT IS RECOMMENDED TO OFFSET FASTENERS ON EACH PICKET AS SHOWN IN DETAIL A.
2. BEGIN BY ATTACHING PICKETS NEXT TO POSTS FIRST. BE SURE TO LEAVE A 1/8" GAP BETWEEN THE POST AND THE PICKET.
 3. CONTINUE BY INSTALLING PICKETS, EQUALLY SPACED IN THE AREA REMAINING.
- NOTE: PICKETS MAY BE INSTALLED USING A NAIL GUN WITH DEPTH SET CAPABILITIES AND APPROPRIATE FASTENERS.

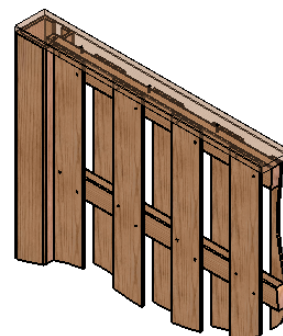

SHADOW BOX DESIGN WITH ALTERNATING PICKETS RECOMMENDED FOR HIGH WIND AREAS

ADDITIONAL INFORMATION

1. COLOR AND WOOD GRAIN MAY VARY AMONG BOARDS.
2. TERRA PICKET MAY "DEFLECT" DEPENDING UPON WEATHER AND ENVIRONMENTAL CONDITIONS.
3. INSTALL TERRA BALUSTERS AT THE BOTTOM OF PICKETS IF UNACCEPTABLE LEVEL OF DEFLECTION OCCURS.
4. ALWAYS CONSULT LOCAL AND REGIONAL BUILDING CODES.



NATURES COMPOSITES™

REMOVING FOOT PRINTS FROM OUR WORLD
1302 INDUSTRIAL PARK AVE.
TORRINGTON, WYOMING 82240
(307) 532-9942

WWW.NATURESCOMPOSITES.COM